

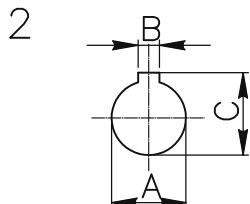

Riduttore RT 45

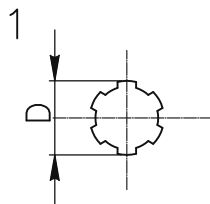
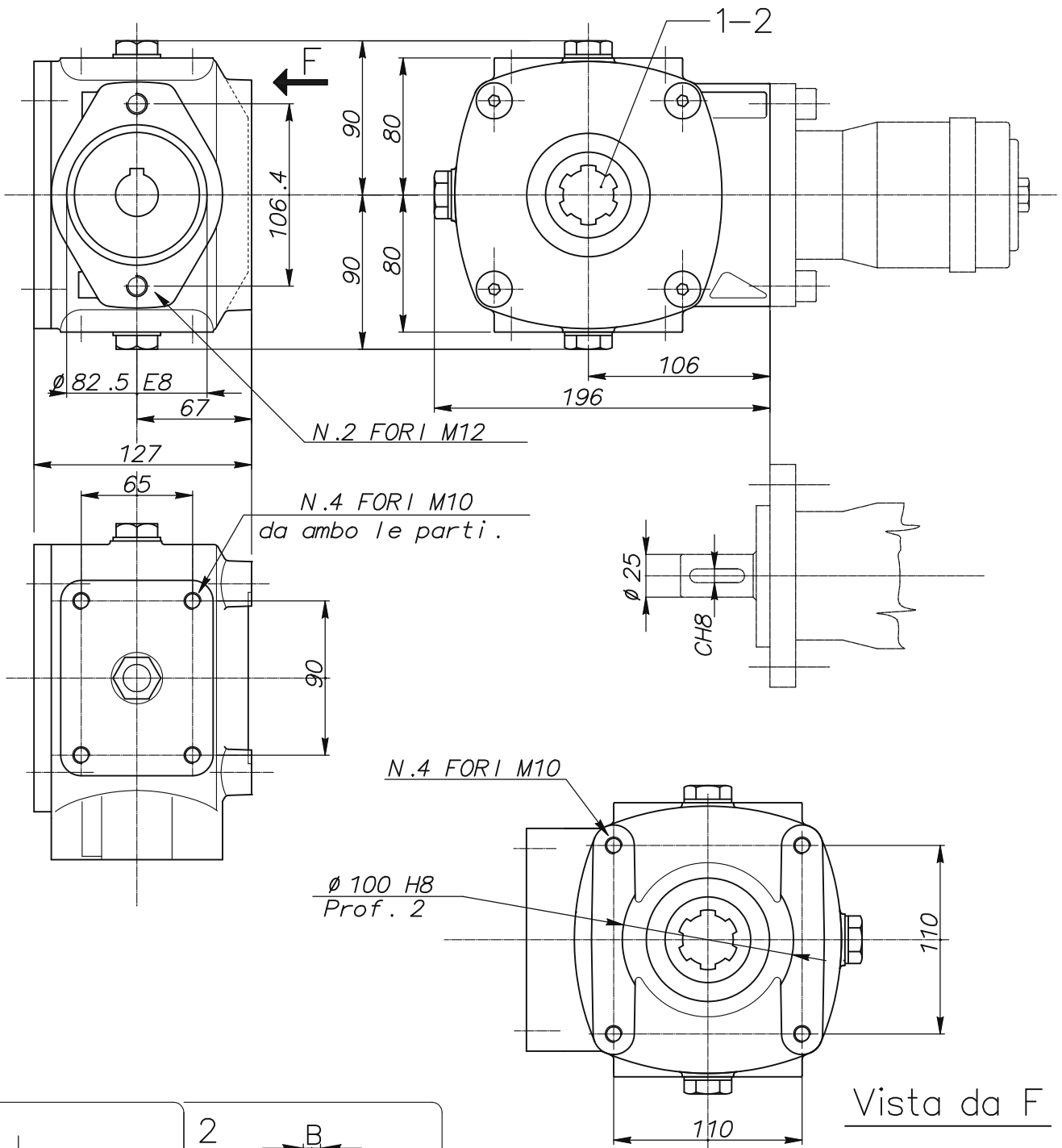

Marca	A E8	B E8	C	D	Peso kg.	Rapporto	Mt.in uscita N m	Olio Tipo	Quantita Kg	Temperatura d'impiego:
9247	30	8	33,8							
9233	35	10	38,8		11	1,9:1	450	SAE 90 EP	0,6	-20° C +80° C
9232				1 3/8" Z6						